

1
**2CH VERTICAL CLADDING U-BRACKET**  
**2VCUB** RESYSTA PROFILE WITHOUT ALUMINUM INSERT (RESGC11223412)

MULTI-BOARD  
SIDE ELEVATION

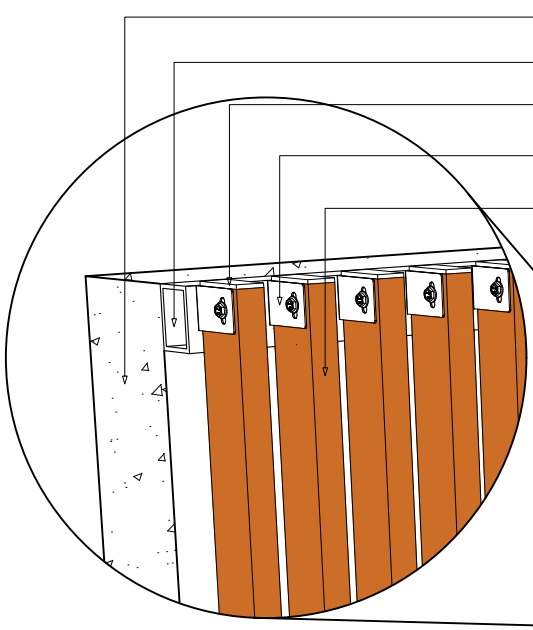

CONTACT  PHONE: 503-360-9551  E-MAIL: sales@hdgbuildingmaterials.com  WEB: hdgbuildingmaterials.com	TITLE  <p style="text-align: center;">2CH - U Bracket VERTICAL CLADDING DETAIL</p>	SPECIFICATION  <p style="text-align: center;">TYPICAL DRAWING DETAIL</p>	SHEET CONTENT PERSPECTIVE TOP VIEW FRONT ELEVATION SIDE ELEVATION MULTI-BOARD SIDE ELEVATION	SHEET SIZE <p style="text-align: center;">A3</p>	DRAWING NO. <p style="text-align: center;">2VCUB-1.1</p>	CONTINENT  <p style="text-align: center;">RESYSTA USA</p>
		CAD BY: C.RE	CHECKED BY:	DATE <p style="text-align: center;">27.02.23</p>	REVISION <p style="text-align: center;">0</p>	



- EXISTING WALL
- SUBSTRUCTURE BY OTHERS
- RESCAP0206Cxx Hollow Cap
- RESUB112234 Aluminum U-Bracket with Bolt, washer and nut
- RESGC112234.12 Cladding (2CH)

**DETAIL - 1.0**  
END PART

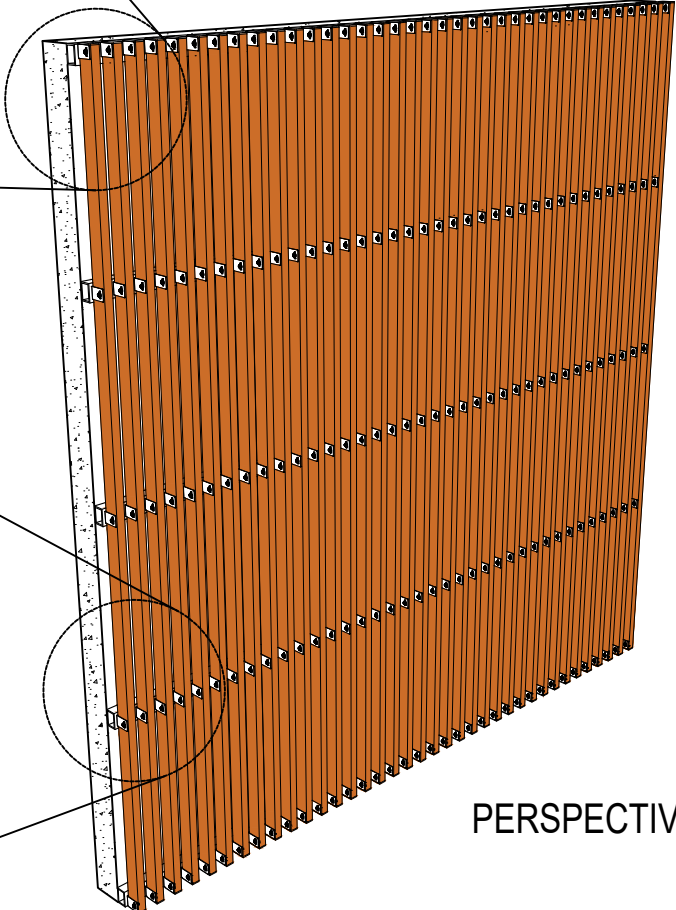

**PERSPECTIVE**

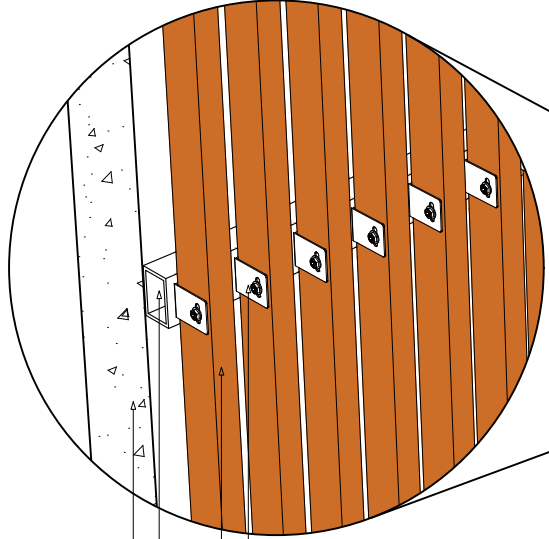

- RESUB112234 Aluminum U-Bracket with Bolt, washer and nut
- RESGC112234.12 Cladding (2CH)
- SUBSTRUCTURE BY OTHERS
- EXISTING WALL

**DETAIL - 2.0**  
MIDDLE PART

**SUB-DETAIL**  
**2VCUB 1.2**  
N.T.S

DIMENSION LEGEND	
Millimeter (mm)	
Inches (") / Foot (')	



CONTACT	TITLE	SHEET CONTENT	
PHONE: 503-360-9551  E-MAIL: sales@hdgbuildingmaterials.com  WEB: hdgbuildingmaterials.com	2CH - U BRACKET <b>VERTICAL CLADDING</b> SUB-DETAIL	PERSPECTIVE	
		DETAIL -1.0	
		DETAIL -2.0	
	SPECIFICATION	DRAWING NO.	DATE
	TYPICAL DRAWING DETAIL	2VCUB-1.2	27.02.23
		CAD BY:	CHECKED BY:

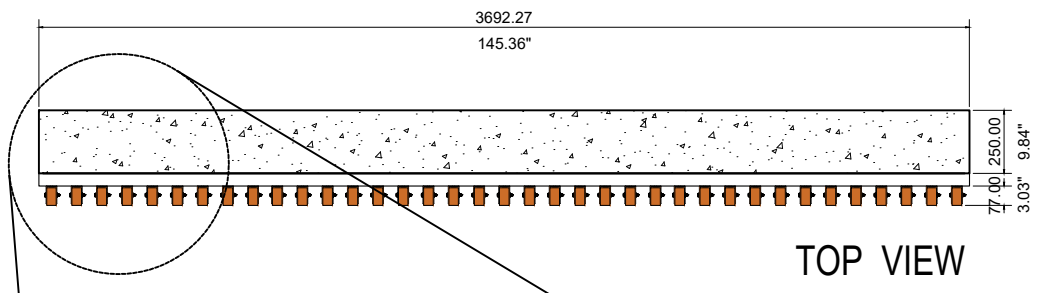

TOP VIEW

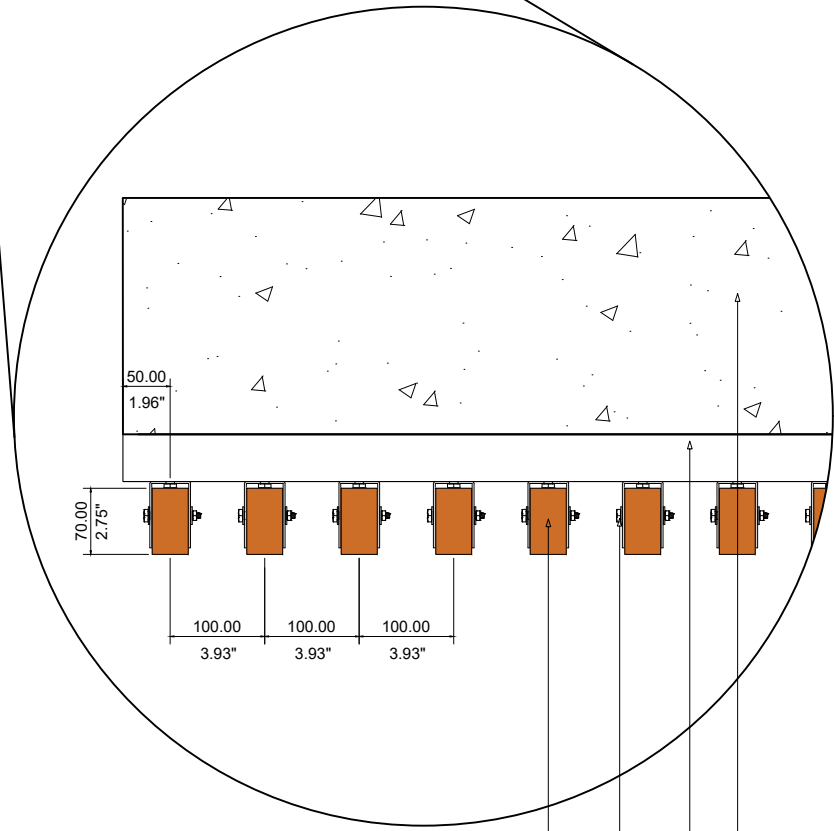

- RESGC11223412 Cladding (2CH) \_\_\_\_\_
- RESUB112234 Aluminum U-Bracket with Bolt, washer and nut \_\_\_\_\_
- SUBSTRUCTURE BY OTHERS \_\_\_\_\_
- EXISTING WALL \_\_\_\_\_

DETAIL - 3.0

**SUB-DETAIL**  
 2VCUB 1.3  
 N.T.S

DIMENSION LEGEND	
Millimeter (mm)	
Inches (") / Foot (')	



CONTACT	TITLE	SHEET CONTENT	
PHONE: 503-360-9551  E-MAIL: sales@hdgbuildingmaterials.com  WEB: hdgbuildingmaterials.com	2CH - U BRACKET <b>VERTICAL CLADDING</b> SUB-DETAIL	TOP VIEW	
		DETAIL -3.0	
	SPECIFICATION	DRAWING NO.	DATE
	TYPICAL DRAWING DETAIL	2VCUB-1.3	27.02.23
		CAD BY:	CHECKED BY:

RESUB112234 Aluminum U-Bracket  
with Bolt, washer and nut

RESCAP0206Cxx Hollow Cap

SUBSTRUCTURE BY OTHERS

RESGC11223412 Cladding (2CH)

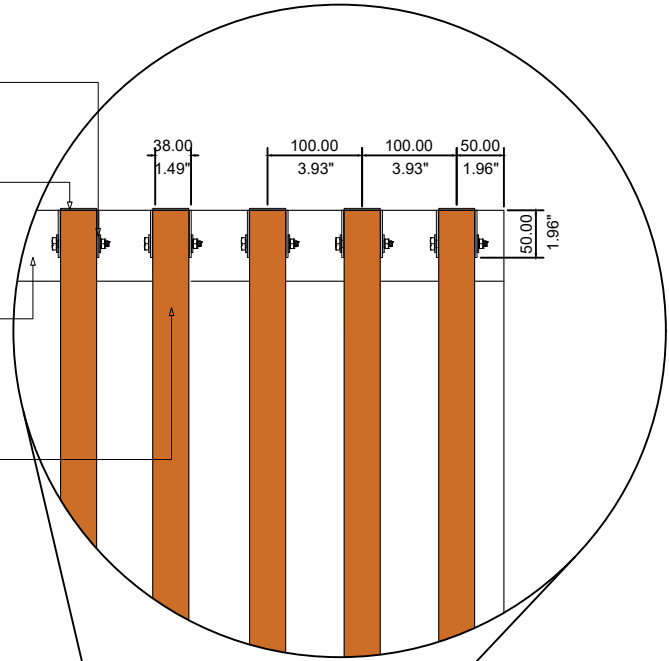

DETAIL - 4.0

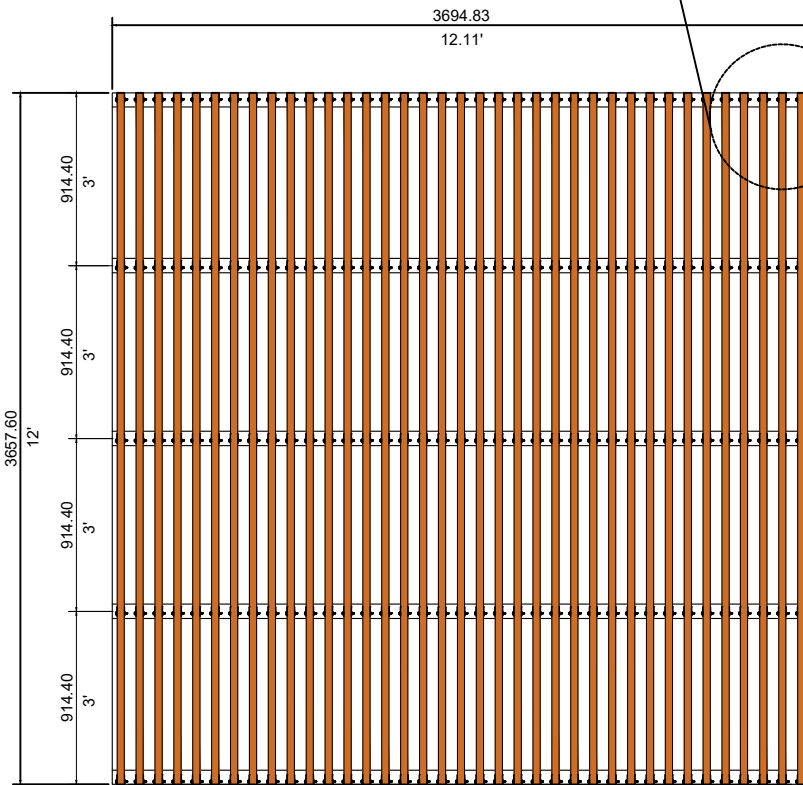

FRONT ELEVATION

**SUB-DETAIL**

2VCUB 1.4

N.T.S

DIMENSION LEGEND

Millimeter (mm)
Inches (") / Foot (')



<b>CONTACT</b>  PHONE: 503-360-9551  E-MAIL: sales@hdgbuildingmaterials.com  WEB: hdgbuildingmaterials.com	<b>TITLE</b>  2CH - U BRACKET <b>VERTICAL CLADDING</b> SUB-DETAIL	<b>SHEET CONTENT</b> FRONT ELEVATION DETAIL-4.0	
	<b>SPECIFICATION</b>  TYPICAL DRAWING DETAIL	<b>DRAWING NO.</b> 2VCUB-1.4	<b>DATE</b> 27.02.23
		<b>CAD BY:</b>	<b>CHECKED BY:</b>

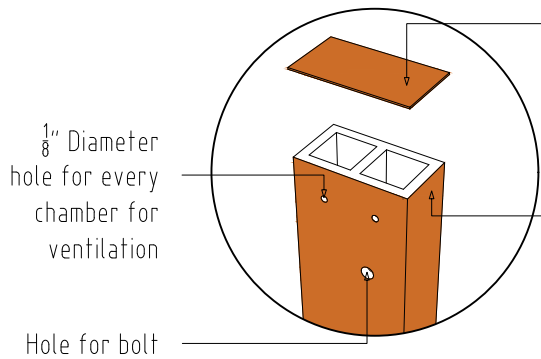

RESCAP0206Cxx  
Hollow Cap

RESGC11223412  
Cladding (2CH)

1/8" Diameter  
hole for every  
chamber for  
ventilation

Hole for bolt

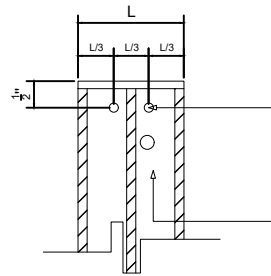

1/8" Diameter hole for  
every chamber for  
ventilation

RESGC11223412

**SECTION**

**DETAIL - 5.1**

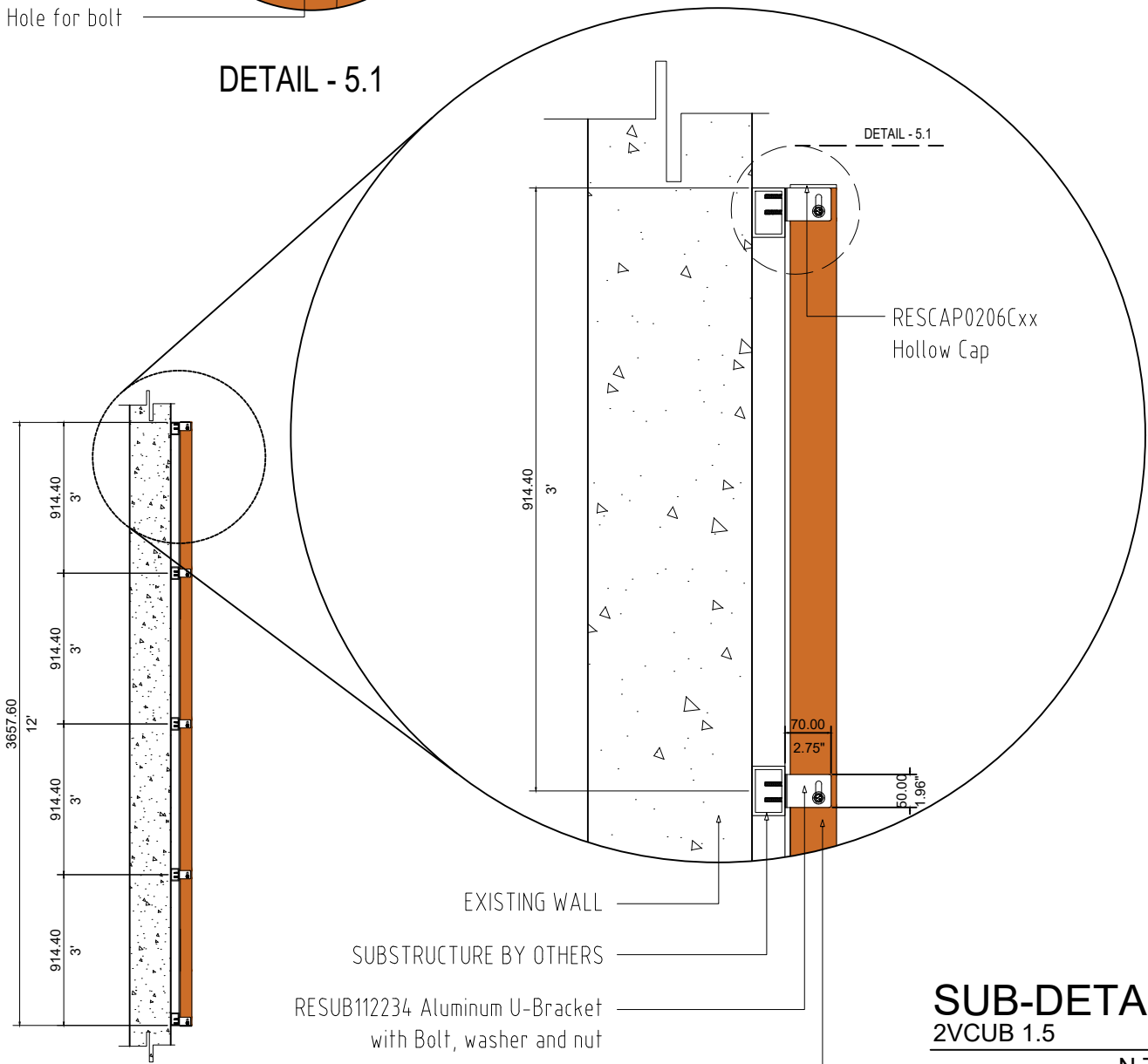

RESCAP0206Cxx  
Hollow Cap

EXISTING WALL

SUBSTRUCTURE BY OTHERS

RESUB112234 Aluminum U-Bracket  
with Bolt, washer and nut

RESGC11223412 Cladding (2CH)

**SUB-DETAIL**  
**2VCUB 1.5**

N.T.S

**SIDE ELEVATION**

**DETAIL - 5.0**

DIMENSION LEGEND	
Millimeter (mm)	
Inches (") / Foot (')	



CONTACT	TITLE	SHEET CONTENT	
PHONE: 503-360-9551  E-MAIL: sales@hdgbuildingmaterials.com  WEB: hdgbuildingmaterials.com	2CH - U BRACKET <b>VERTICAL CLADDING</b> SUB-DETAIL	SIDE ELEVATION	
		DETAIL-5.0	
DETAIL-5.1			
	TYPICAL DRAWING DETAIL	SECTION	
		DRAWING NO.	DATE
		2VCUB-15	27.02.23
		CAD BY:	CHECKED BY:

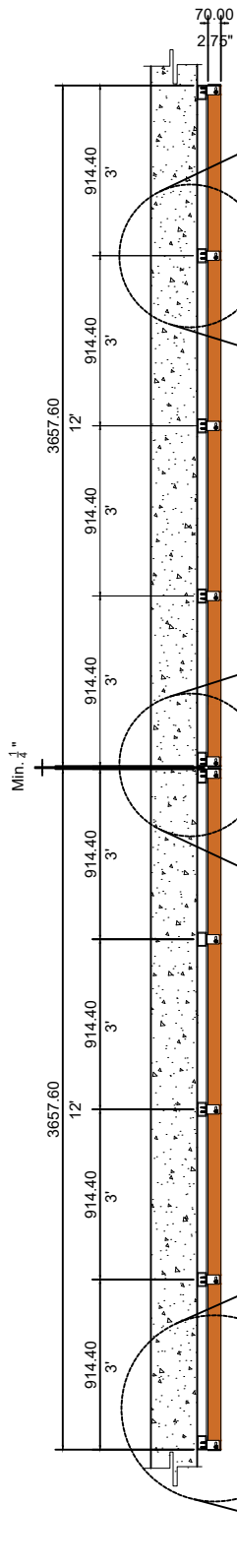

MULTI-BOARD  
SIDE ELEVATION

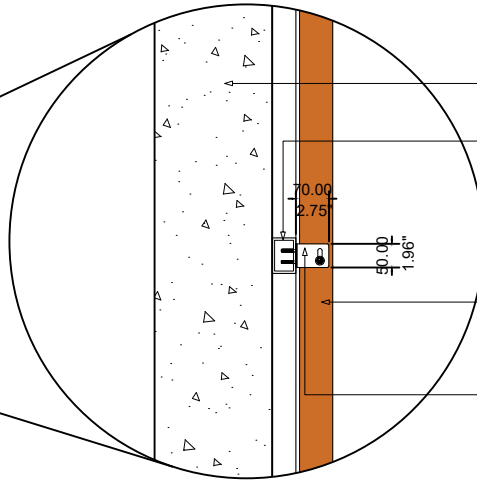

DETAIL - 6.0

- EXISTING WALL
- SUBSTRUCTURE BY OTHERS
- RESGC11223412 Cladding (2CH)
- RESUB112234 Aluminum U-Bracket with Bolt, washer and nut

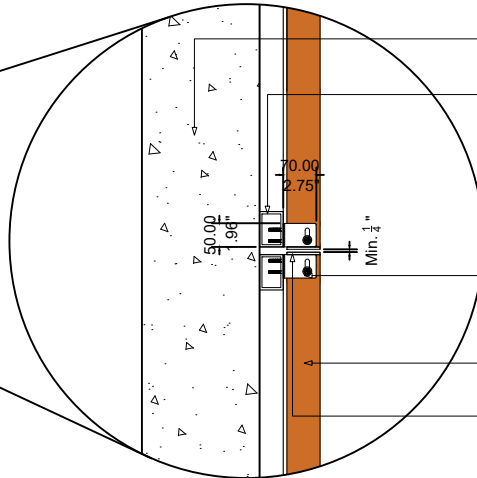

DETAIL - 7.0

- EXISTING WALL
- SUBSTRUCTURE BY OTHERS
- RESUB112234 Aluminum U-Bracket with Bolt, washer and nut
- RESGC11223412 Cladding (2CH)
- RESCAP0206Cxx Hollow Cap

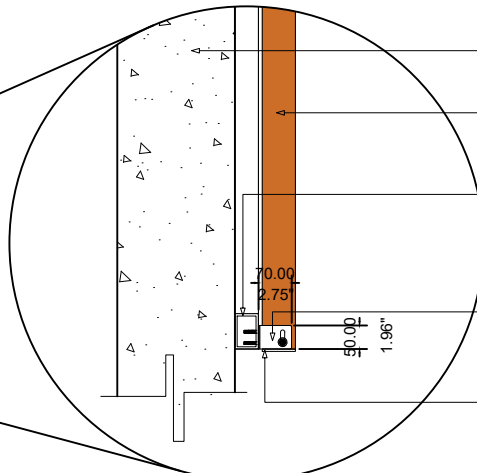

DETAIL - 8.0

- EXISTING WALL
- RESGC11223412 Cladding (2CH)
- SUBSTRUCTURE BY OTHERS
- RESUB112234 Aluminum U-Bracket with Bolt, washer and nut
- RESCAP0206Cxx Hollow Cap

**SUB-DETAIL**  
2VCUB 1.6

N.T.S

DIMENSION LEGEND	
Millimeter (mm)	
Inches (") / Foot (')	



CONTACT	TITLE	SHEET CONTENT	
PHONE: 503-360-9551  E-MAIL: sales@hdgbuildingmaterials.com  WEB: hdgbuildingmaterials.com	2CH - U BRACKET <b>VERTICAL CLADDING</b> SUB-DETAIL	MULTI-BRD SIDE ELEV.	
		DETAIL-6.0	
		DETAIL-7.0	
SPECIFICATION  TYPICAL DRAWING DETAIL		DETAIL-8.0	
		DRAWING NO.	DATE
		2VCUB-16	27.02.23
		CAD BY:	CHECKED BY: