



U-BRS
The BUZON
rail system





THE DEFINITIVE SOLUTION FOR OUTDOOR FLOORING

The U-BRS installation system for outdoor raised floors allows for a simple and cost effective solution for all external terrace applications.

The system can be used for various substrates, 3/4" (20 mm) porcelain, concrete and natural stone pavers.

Practical and functional, the U-BRS system can be used where the void is limited. The system, including the Buzon Pedestal range starts at 1 1/8" (28mm).



U-BRS why choose it?

Practical and functional, the U-BRS system offers a complete structure for the raised installation of your outdoor space.

The system includes adjustable height supports in polypropylene, reinforced aluminium profiles and 1/8" spacer tabs which allow for free drainage to the podium or WPM.

Additionally, 2 rubber strips either side of the spacer tabs assist with potential foot traffic noise.

Locking end-stops prevent potential lateral movement.

U-BRS Advantages



Speed of installation



Economic advantages



High load capability



Allows for random and staggered paver dimensions

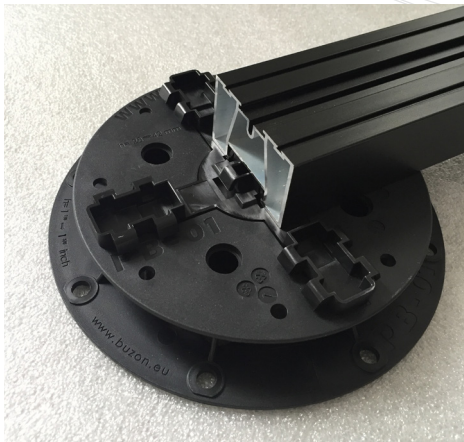



A NEW WAY
OF LIVING
OUTDOORS

U-BRS Product Configuration



SUPPORTS

Models supplied screwed



PB-00



PB-01



PB-1



PB-2



PB-3



PB-4

PB - 00

9 1/16 "

15mm

PB - 01

11 1/8" - 15 1/8"

28 - 42mm

PB - 1

15 1/8" - 2 3/8"

42 - 60mm

PB - 2

2 3/8" - 3 1/2"

60 - 90mm

PB - 3

3 1/2" - 5 3/4"

90 - 145mm

PB - 4

5 3/4" - 9 3/4"

145mm - 245mm

Models supplied unscrewed



PB-5



PB-6



PB-7

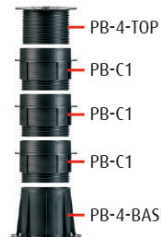

PB-8

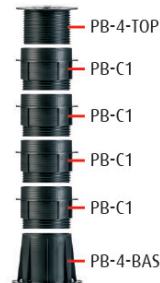

PB-9

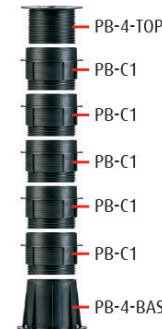

PB-10

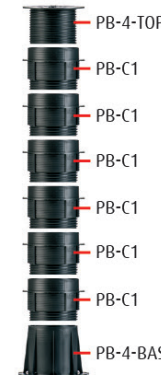

PB-11

PB - 5

9 1/16 - 12 3/8"

230 - 315mm

PB - 6

11 1/8 - 14 7/16"

285 - 367mm

PB - 7

14 7/16 - 19 3/16"

368 - 485mm

PB - 8

17 13/16 - 23 7/8"

452 - 605mm

PB - 9

21 1/16 - 28 5/8"

537 - 725mm

PB - 10

24 3/8 - 33 3/8"

620 - 845mm

PB - 11

27 3/4 - 38 1/8"

705 - 965mm

COMPONENTS

1. CLIP FOR RAIL FIXING ON TOP OF THE PEDESTAL	
<i>PB-KIT-2</i>	Clip for fixing with a tubular joint
2. ALUMINIUM RAIL 2400X65mm	
<i>U-BRS - 11/16" (18mm)</i>	Model with height 11/16" (18mm)
<i>U-BRS - 1 1/2" (38mm)</i>	Model with height 1 1/2" (38mm)
3. EPDM RUBBER STRIP	
<i>U-BRS-EPDM-2MM</i>	Rubber Strip 94 1/2" x 3/16" x 1/16" (2 per rail)
4. SPACER TABS FOR TILES	
<i>U-BRS-TABS-3MM-H17</i>	Fixes into the rail
5. STILL PLATE	
<i>U-BRS-STOP</i>	Clip for the perimeter paving
6. STAINLESS STEEL ACCESSORIES FOR VERTICLE PAVING (TO BE USED WITH L PIECE)	
<i>U-BRS-END-T</i>	Upper element (Top)
<i>U-BRS-END-B</i>	Lower element (Base)
7. CONNECTOR FIXING FOR BETWEEN RAILS	
<i>U-CONNECTOR</i>	For rail or stepped rail mounting

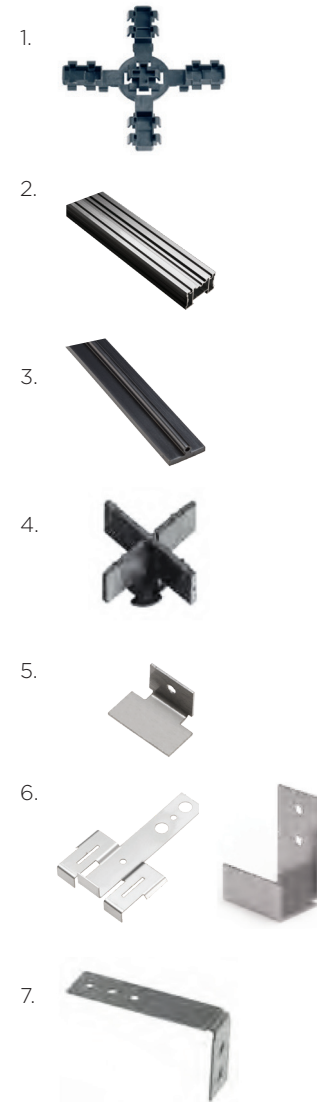

ACCESSORIES

8. SLOPE CORRECTOR

BC-PH5

Slope corrector up to 5%

9. SHIM

PB-SHIMS-4MM

Polypropylene 4mm shim stackable up to 3 high - placed underneath the pedestal for additional height if required

10. BUZON BUBBLE LEVEL

U-KIT-SL-80

Determines the % and direction of the slope

11. ADJUSTMENT KEY

U-KEY

Support height adjustment key

8.



9.



10.



11.



SYSTEM U-BRS 18

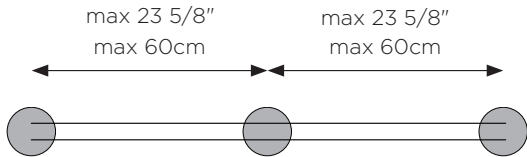

SYSTEM U-BRS 38

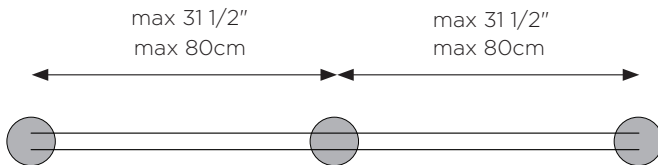

WITH TILES 7 7/8" x 47 1/4" (20 x 120cm)

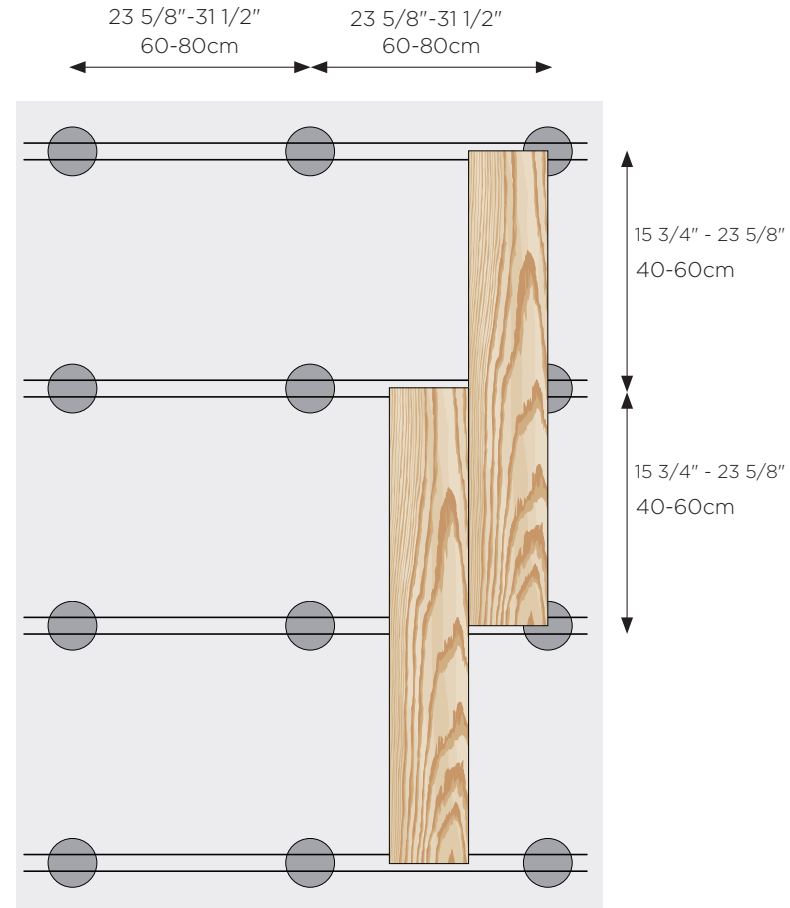

WITH TILES
30x120cm and 40x120cm

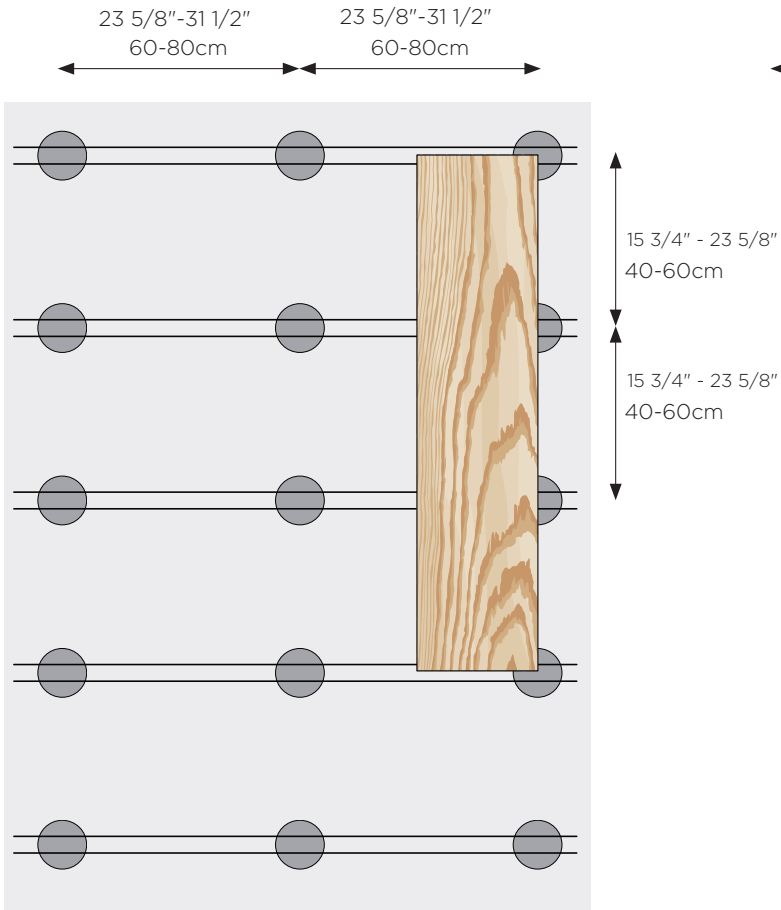

WITH TILES
60x60cm and 60x120cm

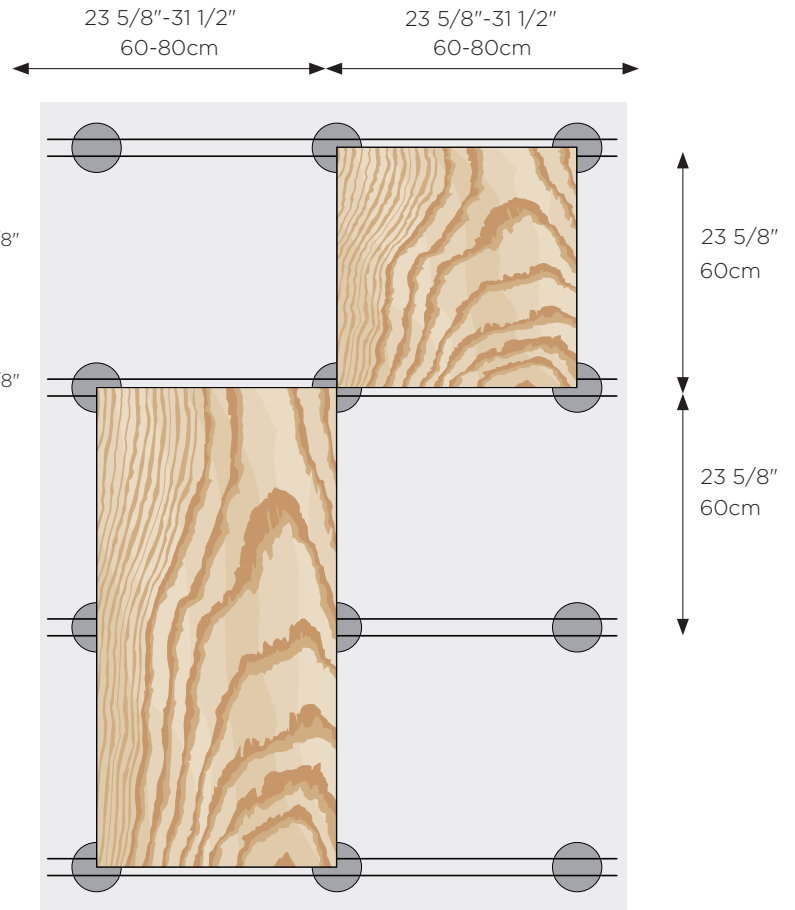



LESS
TIME
PERFECT
RESULTS



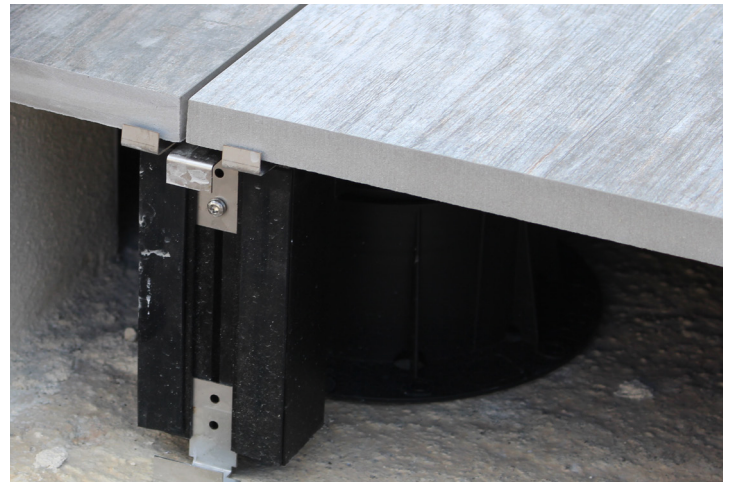
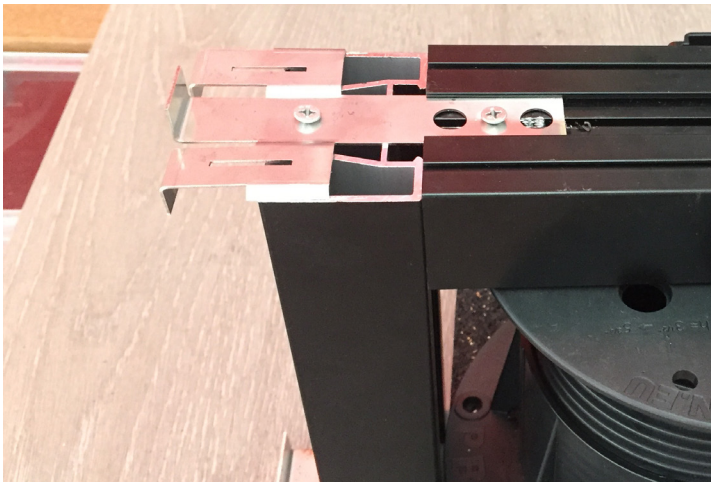

INSTRUCTIONS AND INSTALLATION TIPS

1.

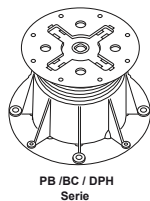

BRS-18 ALU 9 7/16" x 11/16"

EPDM

11/16" (18mm)



3.

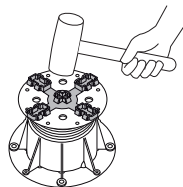
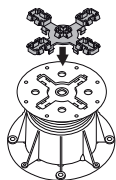
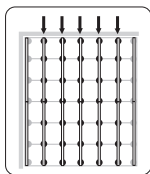
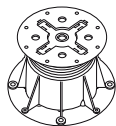

2.

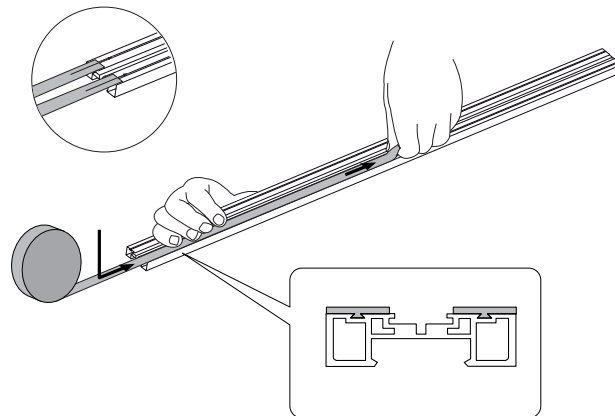

4.

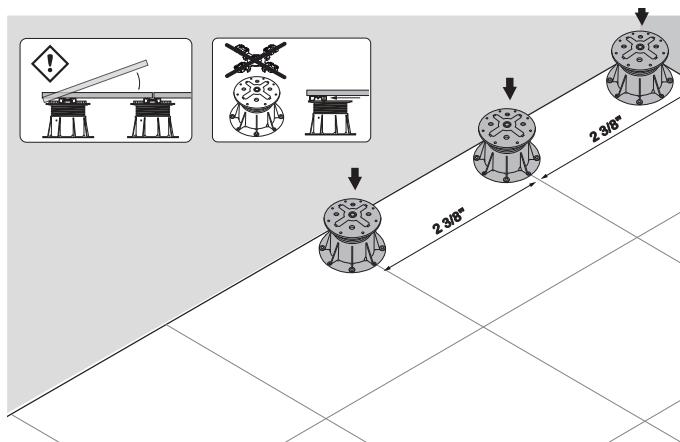

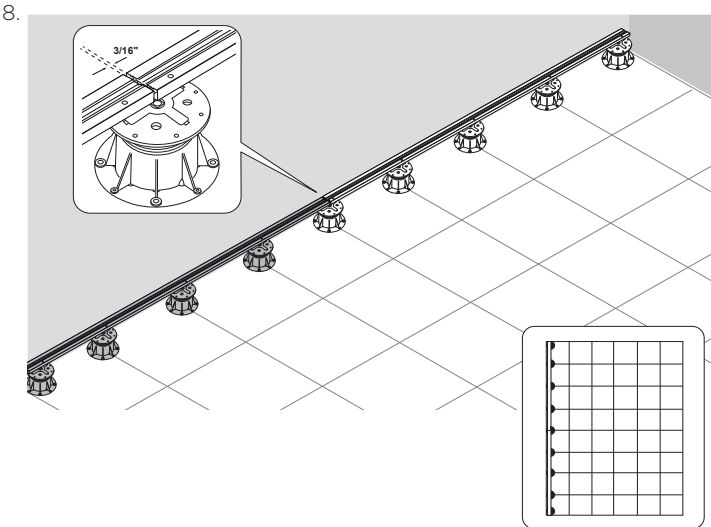
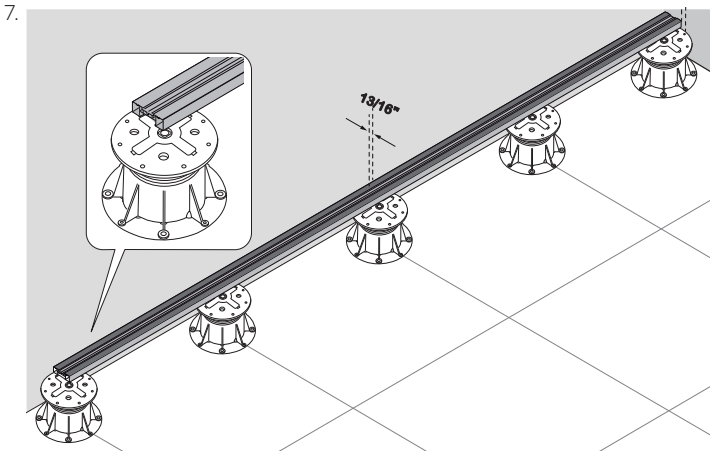
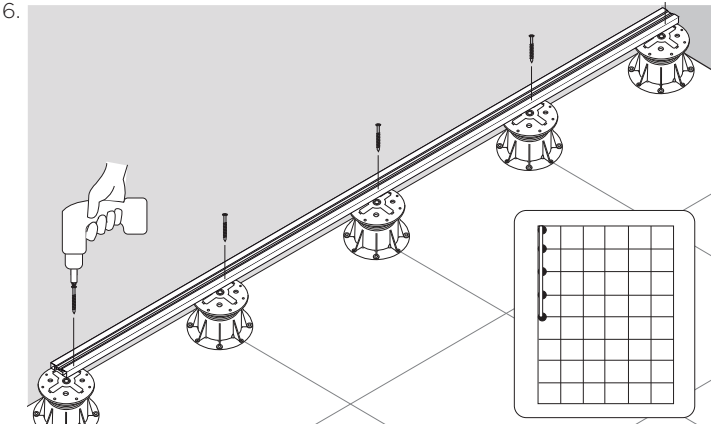
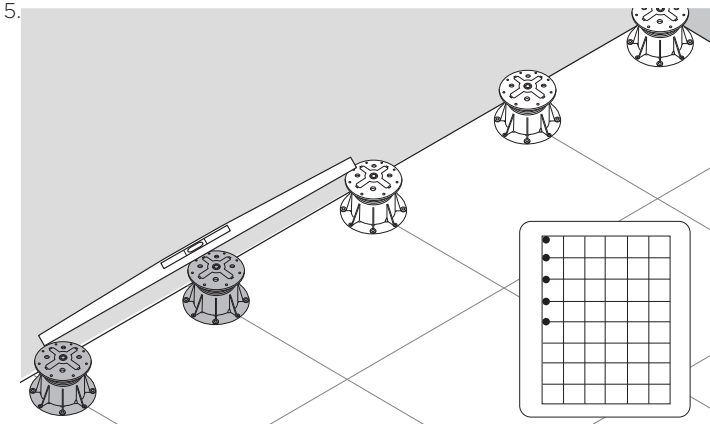

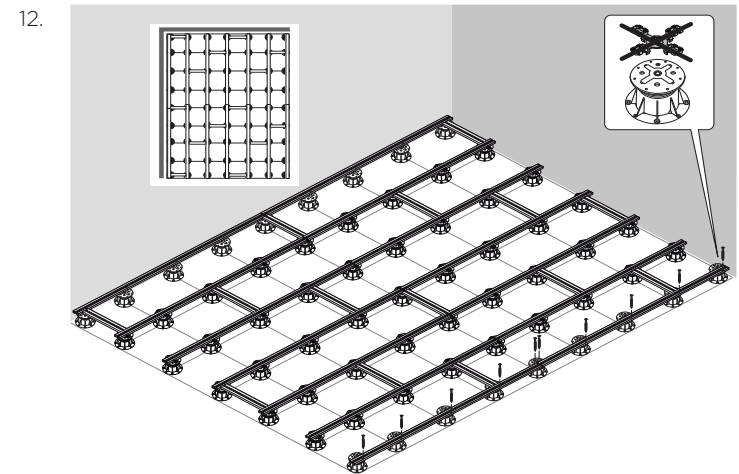
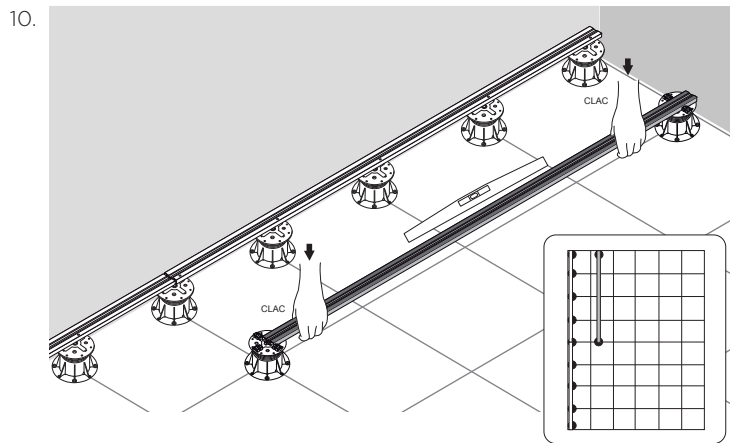
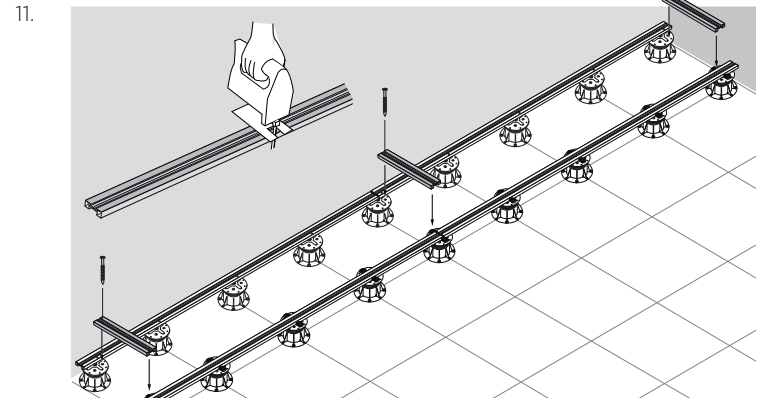
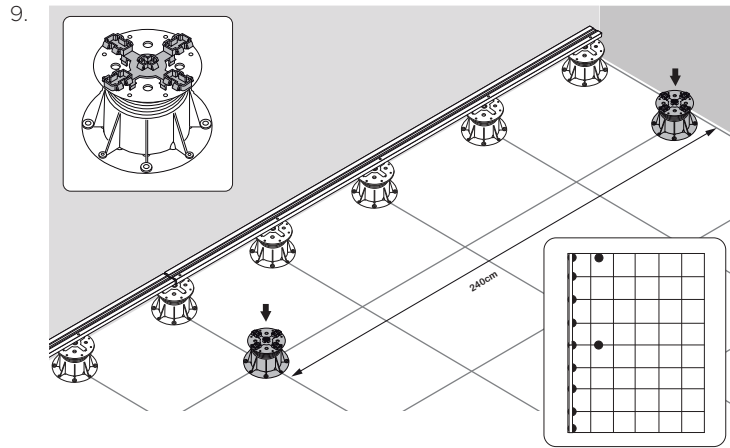



13.

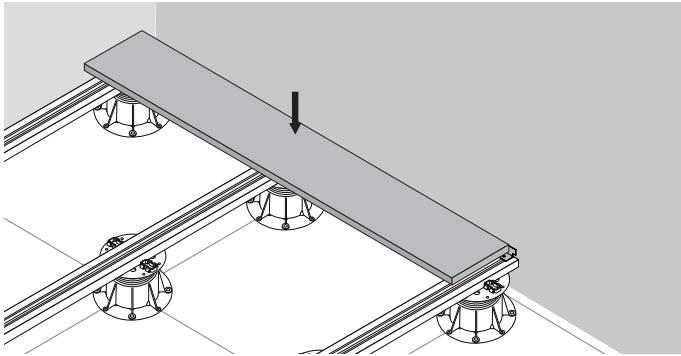

15.

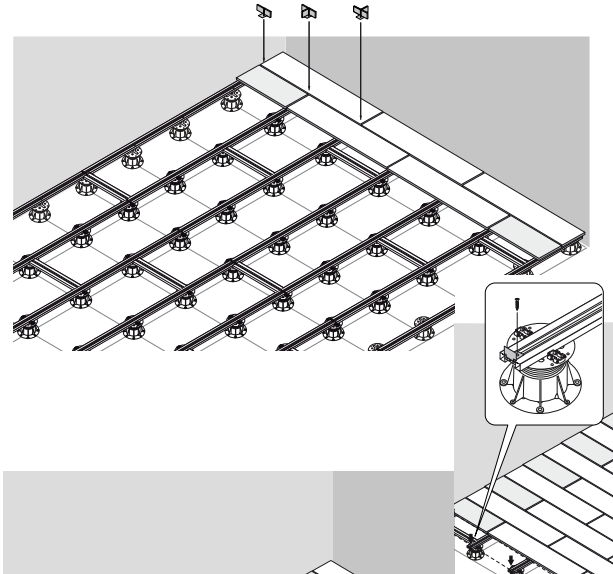

14.

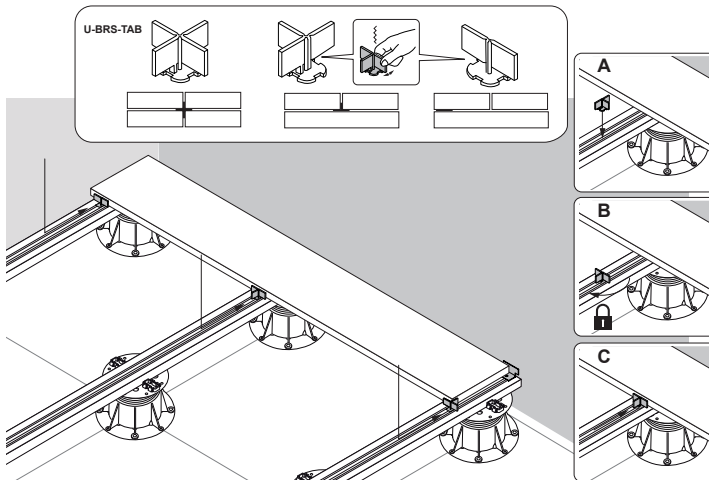

16.

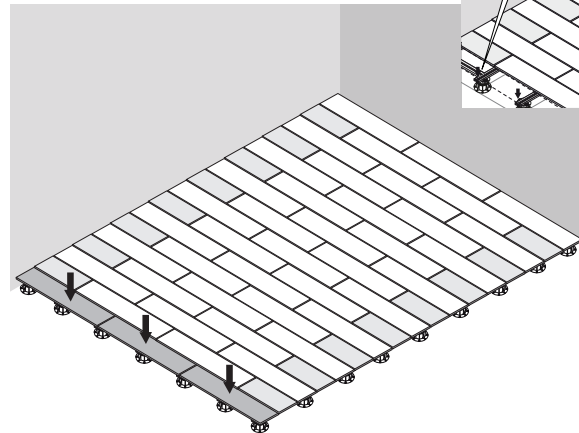







Buzon USA West
(503) 954-3336
sales@buzonusawest.com
buzonpedestals.com